

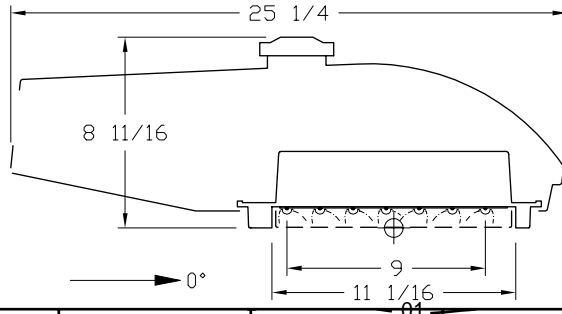

ISOFOOTCANDLE LINES OF HORIZONTAL ILLUMINATION
Values based on 25 foot mounting height.

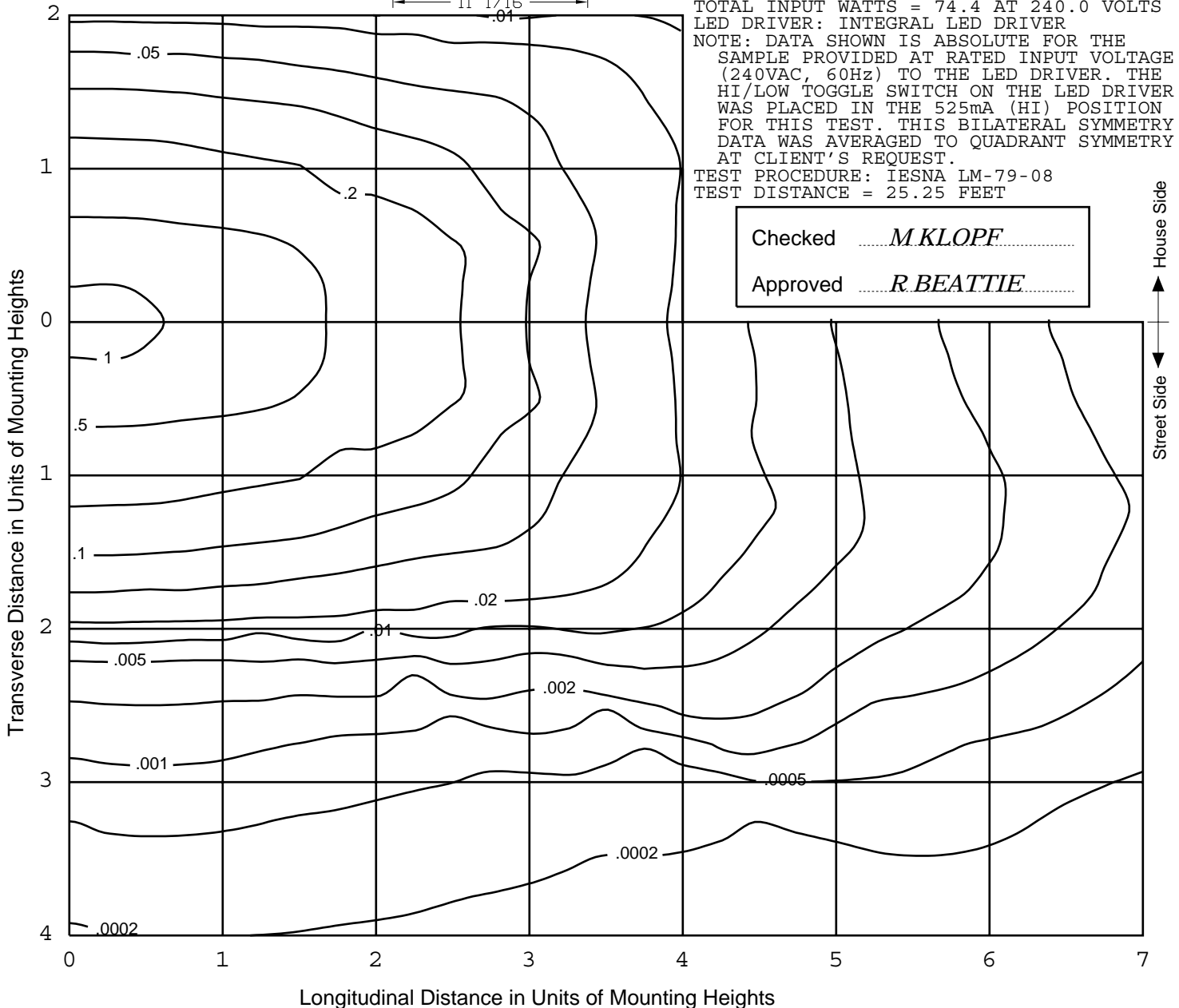

REPORT NUMBER: ITL65045
DATE: 06/10/10
PREPARED FOR: ECOFIT LIGHTING
CATALOG NUMBER: DURASTREET 42 SERIES,
525mA, TYPE 5
LUMINAIRE: CAST METAL HOUSING. ONE LED
MODULE CONSISTING OF: CAST FINNED
METAL HEAT SINK AND LED DRIVER
HOUSING, ONE WHITE CIRCUIT BOARD WITH
SEVEN ROWS OF SIX LEDS, ONE CLEAR
PLASTIC LENS BELOW EACH LED, SEVEN
MOLDED BLACK PLASTIC REFLECTORS WITH
SPECULAR FINISH, CLEAR PLASTIC LENS.
CAST GRAY PAINTED METAL DOOR FRAME.
LED MODULE NOT DISASSEMBLED FOR
INSPECTION.
LAMPS: FORTY-TWO WHITE LIGHT EMITTING
DIODES (LEDS), VERTICAL BASE-UP
POSITION.
TOTAL INPUT WATTS = 74.4 AT 240.0 VOLTS
LED DRIVER: INTEGRAL LED DRIVER
NOTE: DATA SHOWN IS ABSOLUTE FOR THE
SAMPLE PROVIDED AT RATED INPUT VOLTAGE
(240VAC, 60Hz) TO THE LED DRIVER. THE
HI/LOW TOGGLE SWITCH ON THE LED DRIVER
WAS PLACED IN THE 525mA (HI) POSITION
FOR THIS TEST. THIS BILATERAL SYMMETRY
DATA WAS AVERAGED TO QUADRANT SYMMETRY
AT CLIENT'S REQUEST.
TEST PROCEDURE: IESNA LM-79-08
TEST DISTANCE = 25.25 FEET



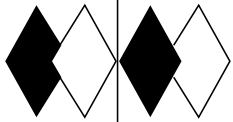

itl boulder
 THE LIGHT CENTER OF THE INDUSTRY SINCE 1955

INDEPENDENT TESTING LABORATORIES, INC.
 3386 LONGHORN ROAD, BOULDER, CO 80302 USA

PHONE: (303)442-1255 • FAX: (303)449-5274 • E-MAIL: itl@itlboulder.com • WEBSITE: www.itlboulder.com

REPORT NUMBER: ITL65045
 DATE: 06/10/10
 PREPARED FOR: ECOFIT LIGHTING
 CATALOG NUMBER: DURASTREET 42 SERIES,
 525mA, TYPE 5
 LUMINAIRE: CAST METAL HOUSING. ONE LED
 MODULE CONSISTING OF: CAST FINNED
 METAL HEAT SINK AND LED DRIVER
 HOUSING, ONE WHITE CIRCUIT BOARD WITH
 SEVEN ROWS OF SIX LEDS, ONE CLEAR
 PLASTIC LENS BELOW EACH LED, SEVEN
 MOLDED BLACK PLASTIC REFLECTORS WITH
 SPECULAR FINISH, CLEAR PLASTIC LENS.
 CAST GRAY PAINTED METAL DOOR FRAME.
 LED MODULE NOT DISASSEMBLED FOR
 INSPECTION.
 LAMPS: FORTY-TWO WHITE LIGHT EMITTING
 DIODES (LEDS), VERTICAL BASE-UP
 POSITION.
 TOTAL INPUT WATTS = 74.4 AT 240.0
 VOLTS
 LED DRIVER: INTEGRAL LED DRIVER
 NOTE: DATA SHOWN IS ABSOLUTE FOR THE
 SAMPLE PROVIDED AT RATED INPUT VOLTAGE
 (240VAC, 60Hz) TO THE LED DRIVER. THE
 HI/LOW TOGGLE SWITCH ON THE LED DRIVER
 WAS PLACED IN THE 525mA (HI) POSITION
 FOR THIS TEST. THIS BILATERAL SYMMETRY
 DATA WAS AVERAGED TO QUADRANT SYMMETRY
 AT CLIENT'S REQUEST.
 TEST PROCEDURE: IESNA LM-79-08
 TEST DISTANCE = 25.25 FEET

MAXIMUM PLANE AND MAXIMUM CONE PLOTS OF CANDELA

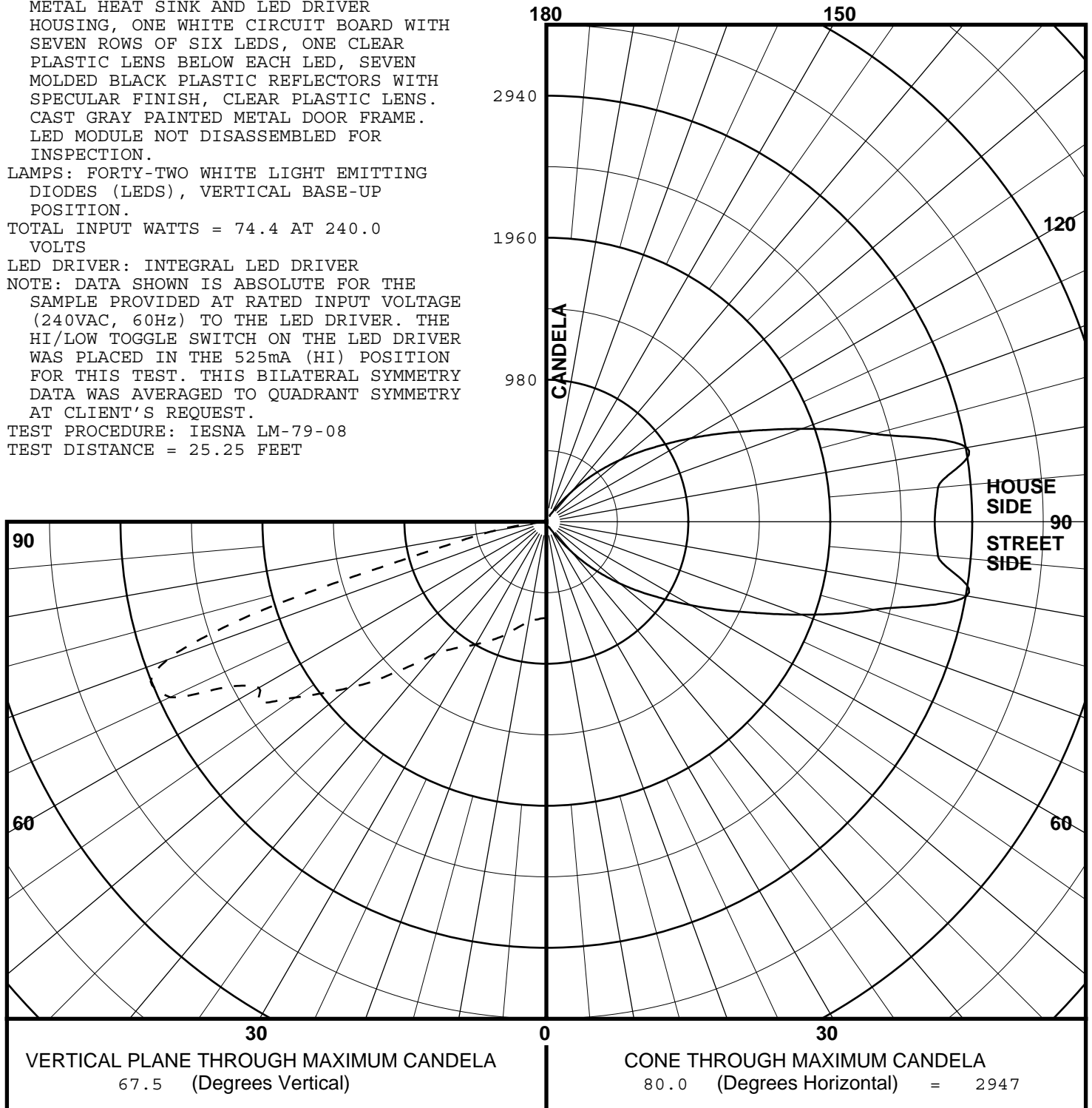



REPORT NUMBER: ITL65045
 DATE: 06/10/10
 PREPARED FOR: ECOFIT LIGHTING

COEFFICIENTS OF UTILIZATION AND FLUX DISTRIBUTION

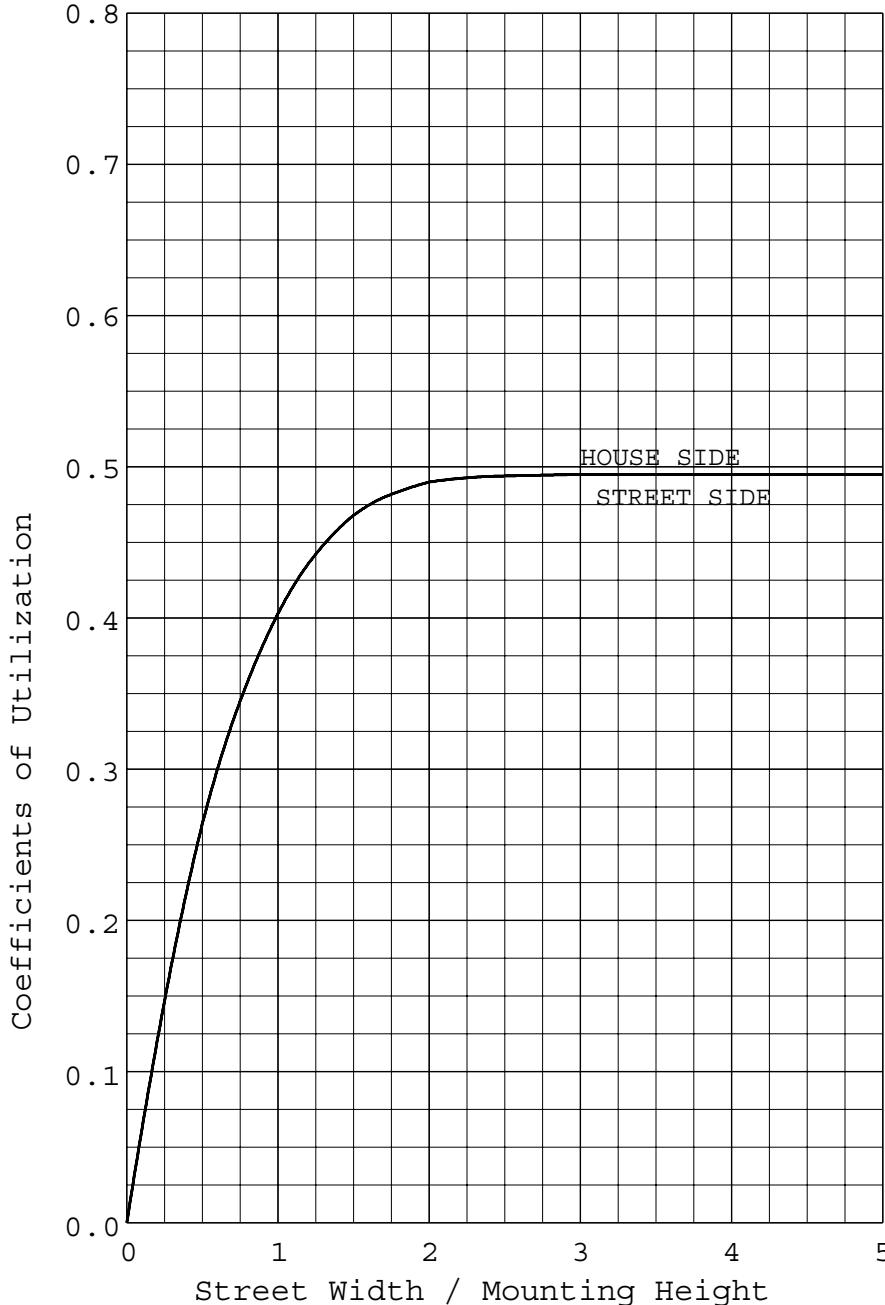

	LUMENS	PERCENT OF FIXTURE
DOWNWARD STREET SIDE	2096.	50.0
DOWNWARD HOUSE SIDE	2096.	50.0
DOWNWARD TOTAL	4192.	100.0
UPWARD STREET SIDE	0.	0.0
UPWARD HOUSE SIDE	0.	0.0
UPWARD TOTAL	0.	0.0
TOTAL FLUX	4192.	100.0
EFFICACY = 56.3 Lm/W		

ALL CANDELA AND LUMENS IN THIS REPORT ARE BASED ON ABSOLUTE PHOTOMETRY. THE COEFFICIENT OF UTILIZATION VALUES ARE BASED ON THE TOTAL ABSOLUTE LUMEN OUTPUT OF THIS LUMINAIRE SAMPLE.



itl boulder
THE LIGHT CENTER OF THE INDUSTRY SINCE 1955

INDEPENDENT TESTING LABORATORIES, INC.
 3386 LONGHORN ROAD, BOULDER, CO 80302 USA

PHONE: (303)442-1255 • FAX: (303)449-5274 • E-MAIL: itl@itlboulder.com • WEBSITE: www.itlboulder.com

REPORT NUMBER: ITL65045
 DATE: 06/10/10
 PREPARED FOR: ECOFIT LIGHTING

FLUX DISTRIBUTION BY SOLID ANGLE

(PER IESNA TM-15-07, LUMINAIRE CLASSIFICATION SYSTEM FOR OUTDOOR LUMINAIRES)

	LUMENS	PERCENT OF FIXTURE	BUG ZONE RATINGS
FORWARD LIGHT	2096.	50.0	
FL (0- 30)	322.5	7.7	
FM (30- 60)	1071.6	25.6	
FH (60- 80)	687.8	16.4	G1
FVH(80- 90)	14.0	0.3	U1 G1
BACK LIGHT	2096.	50.0	
BL (0- 30)	322.5	7.7	B1
BM (30- 60)	1071.6	25.6	B2
BH (60- 80)	687.8	16.4	B2 G2
BVH(80- 90)	14.0	0.3	U1 G1
UPLIGHT	0.	0.0	
UL (90-100)	0.0	0.0	U0
UH (100-180)	0.0	0.0	U0
TRAPPED LIGHT	0.	0.0	
TOTAL FLUX	4192.	100.0	

BACKLIGHT, UPLIGHT, AND GLARE (BUG) RATINGS
 (PER ADDENDUM A FOR IESNA TM-15-07)

BUG RATING: B2 U1 G2



itl boulder

THE LIGHT CENTER OF THE INDUSTRY SINCE 1955

INDEPENDENT TESTING LABORATORIES, INC.
3386 LONGHORN ROAD, BOULDER, CO 80302 USA

PHONE: (303)442-1255 • FAX: (303)449-5274 • E-MAIL: itl@itlboulder.com • WEBSITE: www.itlboulder.com

REPORT NUMBER: ITL65045
PREPARED FOR: ECOFIT LIGHTING

DATE: 06/10/10

CANDELA TABULATION

	STREET SIDE											LATERAL ANGLE										
	0.0	5.0	15.0	25.0	35.0	45.0	55.0	65.0	75.0	80.0	85.0	0.0	5.0	15.0	25.0	35.0	45.0	55.0	65.0	75.0	80.0	85.0
	90.0	0.	0.	0.	0.	0.	0.	0.	0.	0.	0.	90.0	0.	0.	0.	0.	0.	0.	0.	0.	0.	0.
	87.5	1.	0.	0.	1.	2.	3.	4.	6.	11.	12.	87.5	1.	0.	0.	1.	2.	3.	4.	6.	11.	12.
	85.0	2.	1.	2.	3.	4.	5.	8.	15.	34.	44.	85.0	2.	1.	2.	3.	4.	5.	8.	15.	34.	44.
	82.5	3.	3.	3.	5.	6.	8.	13.	34.	125.	172.	82.5	3.	3.	3.	5.	6.	8.	13.	34.	125.	172.
	80.0	4.	5.	5.	7.	9.	12.	22.	137.	417.	382.	80.0	4.	5.	5.	7.	9.	12.	22.	137.	417.	382.
	77.5	6.	7.	8.	10.	13.	18.	40.	574.	826.	602.	77.5	6.	7.	8.	10.	13.	18.	40.	574.	826.	602.
	75.0	9.	10.	12.	14.	18.	27.	118.	1021.	1133.	1059.	75.0	9.	10.	12.	14.	18.	27.	118.	1021.	1133.	1059.
	72.5	13.	15.	17.	19.	25.	51.	411.	1400.	1526.	2140.	72.5	13.	15.	17.	19.	25.	51.	411.	1400.	1526.	2140.
	70.0	18.	19.	22.	27.	39.	195.	692.	1511.	1930.	2787.	70.0	18.	19.	22.	27.	39.	195.	692.	1511.	1930.	2787.
	67.5<<	24.	26.	31.	42.	125.	460.	886.	1470.	2343.	2947.	67.5<<	24.	26.	31.	42.	125.	460.	886.	1470.	2343.	2947.
	67.0	25.	26.	32.	45.	143.	481.	903.	1464.	2391.	2936.	67.0	25.	26.	32.	45.	143.	481.	903.	1464.	2391.	2936.
	65.0	40.	42.	59.	131.	347.	619.	1007.	1292.	2524.	2866.	65.0	40.	42.	59.	131.	347.	619.	1007.	1292.	2524.	2866.
	62.5	124.	130.	190.	323.	471.	711.	1120.	1173.	2334.	2461.	62.5	124.	130.	190.	323.	471.	711.	1120.	1173.	2334.	2461.
	60.0	282.	286.	331.	421.	543.	746.	1116.	1259.	2389.	2292.	60.0	282.	286.	331.	421.	543.	746.	1116.	1259.	2389.	2292.
V	57.5	355.	359.	394.	481.	599.	748.	1014.	1313.	2311.	2327.	57.5	355.	359.	394.	481.	599.	748.	1014.	1313.	2311.	2327.
E	55.0	411.	415.	449.	526.	619.	765.	890.	1477.	2086.	2114.	55.0	411.	415.	449.	526.	619.	765.	890.	1477.	2086.	2114.
R	52.5	453.	454.	477.	543.	631.	773.	835.	1581.	1892.	1942.	52.5	453.	454.	477.	543.	631.	773.	835.	1581.	1892.	1942.
T	50.0	470.	472.	490.	557.	650.	703.	827.	1545.	1730.	1785.	50.0	470.	472.	490.	557.	650.	703.	827.	1545.	1730.	1785.
I	47.5	487.	489.	510.	575.	643.	638.	930.	1427.	1567.	1636.	47.5	487.	489.	510.	575.	643.	638.	930.	1427.	1567.	1636.
C	45.0	508.	508.	528.	584.	579.	626.	1061.	1313.	1429.	1465.	45.0	508.	508.	528.	584.	579.	626.	1061.	1313.	1429.	1465.
A	42.5	530.	527.	530.	529.	554.	671.	1092.	1180.	1268.	1319.	42.5	530.	527.	530.	529.	554.	671.	1092.	1180.	1268.	1319.
L	40.0	484.	484.	482.	504.	559.	824.	1049.	1100.	1147.	1184.	40.0	484.	484.	482.	504.	559.	824.	1049.	1100.	1147.	1184.
	37.5	462.	464.	472.	507.	633.	933.	998.	1038.	1085.	1116.	37.5	462.	464.	472.	507.	633.	933.	998.	1038.	1085.	1116.
A	35.0	467.	470.	486.	566.	802.	922.	946.	985.	1034.	1060.	35.0	467.	470.	486.	566.	802.	922.	946.	985.	1034.	1060.
N	32.5	519.	527.	579.	731.	849.	890.	921.	946.	994.	1019.	32.5	519.	527.	579.	731.	849.	890.	921.	946.	994.	1019.
G	30.0	686.	692.	739.	784.	829.	852.	883.	916.	959.	978.	30.0	686.	692.	739.	784.	829.	852.	883.	916.	959.	978.
L	27.5	738.	737.	749.	771.	798.	819.	856.	885.	927.	939.	27.5	738.	737.	749.	771.	798.	819.	856.	885.	927.	939.
E	25.0	732.	732.	741.	751.	769.	795.	825.	860.	894.	903.	25.0	732.	732.	741.	751.	769.	795.	825.	860.	894.	903.
	22.5	715.	714.	719.	727.	745.	775.	797.	833.	863.	867.	22.5	715.	714.	719.	727.	745.	775.	797.	833.	863.	867.
	20.0	699.	697.	703.	713.	733.	749.	772.	805.	828.	830.	20.0	699.	697.	703.	713.	733.	749.	772.	805.	828.	830.
	17.5	694.	693.	698.	703.	712.	729.	752.	776.	790.	791.	17.5	694.	693.	698.	703.	712.	729.	752.	776.	790.	791.
	15.0	683.	683.	686.	691.	701.	714.	734.	748.	754.	754.	15.0	683.	683.	686.	691.	701.	714.	734.	748.	754.	754.
	12.5	677.	678.	682.	687.	694.	703.	714.	721.	725.	725.	12.5	677.	678.	682.	687.	694.	703.	714.	721.	725.	725.
	10.0	676.	676.	678.	684.	689.	693.	697.	701.	700.	700.	10.0	676.	676.	678.	684.	689.	693.	697.	701.	700.	700.
	7.5	675.	676.	677.	680.	683.	684.	684.	684.	685.	684.	7.5	675.	676.	677.	680.	683.	684.	684.	684.	685.	684.
	5.0	669.	669.	669.	671.	672.	674.	674.	676.	677.	676.	5.0	669.	669.	669.	671.	672.	674.	674.	676.	677.	676.
	2.5	665.	664.	665.	665.	666.	666.	667.	667.	667.	667.	2.5	665.	664.	665.	665.	666.	666.	667.	667.	667.	667.
	0.0	665.	665.	665.	665.	665.	665.	665.	665.	665.	665.	0.0	665.	665.	665.	665.	665.	665.	665.	665.	665.	665.

PLANE OF MAXIMUM CANDELA

CONE OF MAXIMUM CANDELA

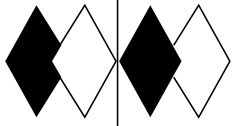

itl boulder
THE LIGHT CENTER OF THE INDUSTRY SINCE 1955

INDEPENDENT TESTING LABORATORIES, INC.
 3386 LONGHORN ROAD, BOULDER, CO 80302 USA

PHONE: (303)442-1255 • FAX: (303)449-5274 • E-MAIL: itl@itlboulder.com • WEBSITE: www.itlboulder.com

REPORT NUMBER: ITL65045
 PREPARED FOR: ECOFIT LIGHTING

DATE: 06/10/10

CANDELA TABULATION

	HOUSE SIDE	LATERAL ANGLE										
	90.0	95.0	100.0	105.0	115.0	125.0	135.0	145.0	155.0	165.0	175.0	
	90.0	0.	0.	0.	0.	0.	0.	0.	0.	0.	0.	0.
	87.5	10.	11.	12.	11.	6.	4.	3.	2.	1.	0.	0.
	85.0	34.	35.	44.	34.	15.	8.	5.	4.	3.	2.	1.
	82.5	90.	107.	172.	125.	34.	13.	8.	6.	5.	3.	3.
	80.0	229.	282.	382.	417.	137.	22.	12.	9.	7.	5.	5.
	77.5	545.	614.	602.	826.	574.	40.	18.	13.	10.	8.	7.
	75.0	886.	947.	1059.	1133.	1021.	118.	27.	18.	14.	12.	10.
	72.5	1593.	1728.	2140.	1526.	1400.	411.	51.	25.	19.	17.	15.
	70.0	2361.	2461.	2787.	1930.	1511.	692.	195.	39.	27.	22.	19.
	67.5<<	2681.	2714.	2947.	2343.	1470.	886.	460.	125.	42.	31.	26.
	67.0	2693.	2717.	2936.	2391.	1464.	903.	481.	143.	45.	32.	26.
	65.0	2718.	2689.	2866.	2524.	1292.	1007.	619.	347.	131.	59.	42.
	62.5	2449.	2399.	2461.	2334.	1173.	1120.	711.	471.	323.	190.	130.
	60.0	2258.	2243.	2292.	2389.	1259.	1116.	746.	543.	421.	331.	286.
V	57.5	2384.	2353.	2327.	2311.	1313.	1014.	748.	599.	481.	394.	359.
E	55.0	2187.	2177.	2114.	2086.	1477.	890.	765.	619.	526.	449.	415.
R	52.5	2027.	2008.	1942.	1892.	1581.	835.	773.	631.	543.	477.	454.
T	50.0	1860.	1851.	1785.	1730.	1545.	827.	703.	650.	557.	490.	472.
I	47.5	1700.	1692.	1636.	1567.	1427.	930.	638.	643.	575.	510.	489.
C	45.0	1513.	1509.	1465.	1429.	1313.	1061.	626.	579.	584.	528.	508.
A	42.5	1381.	1372.	1319.	1268.	1180.	1092.	671.	554.	529.	530.	527.
L	40.0	1224.	1219.	1184.	1147.	1100.	1049.	824.	559.	504.	482.	484.
	37.5	1146.	1142.	1116.	1085.	1038.	998.	933.	633.	507.	472.	464.
A	35.0	1087.	1081.	1060.	1034.	985.	946.	922.	802.	566.	486.	470.
N	32.5	1031.	1030.	1019.	994.	946.	921.	890.	849.	731.	579.	527.
G	30.0	987.	987.	978.	959.	916.	883.	852.	829.	784.	739.	692.
L	27.5	945.	943.	939.	927.	885.	856.	819.	798.	771.	749.	737.
E	25.0	905.	905.	903.	894.	860.	825.	795.	769.	751.	741.	732.
	22.5	870.	870.	867.	863.	833.	797.	775.	745.	727.	719.	714.
	20.0	831.	832.	830.	828.	805.	772.	749.	733.	713.	703.	697.
	17.5	791.	792.	791.	790.	776.	752.	729.	712.	703.	698.	693.
	15.0	757.	756.	754.	754.	748.	734.	714.	701.	691.	686.	683.
	12.5	727.	727.	725.	725.	721.	714.	703.	694.	687.	682.	678.
	10.0	700.	700.	700.	700.	701.	697.	693.	689.	684.	678.	676.
	7.5	684.	684.	684.	685.	684.	684.	684.	683.	680.	677.	676.
	5.0	676.	677.	676.	677.	676.	674.	674.	672.	671.	669.	669.
	2.5	667.	667.	667.	667.	667.	667.	666.	666.	665.	665.	664.
	0.0	665.	665.	665.	665.	665.	665.	665.	665.	665.	665.	665.

CONE OF MAXIMUM CANDELA

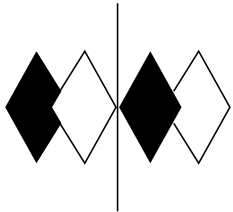

itl boulder
THE LIGHT CENTER OF THE INDUSTRY SINCE 1955

INDEPENDENT TESTING LABORATORIES, INC.
 3386 LONGHORN ROAD, BOULDER, CO 80302 USA

PHONE: (303)442-1255 • FAX: (303)449-5274 • E-MAIL: itl@itlboulder.com • WEBSITE: www.itlboulder.com

REPORT NUMBER: ITL65045
 PREPARED FOR: ECOFIT LIGHTING

DATE: 06/10/10

CANDELA TABULATION

HOUSE SIDE	LATERAL ANGLE
180.0	
90.0	0.
87.5	1.
85.0	2.
82.5	3.
80.0	4.
77.5	6.
75.0	9.
72.5	13.
70.0	18.
67.5<<	24.
67.0	25.
65.0	40.
62.5	124.
60.0	282.
V 57.5	355.
E 55.0	411.
R 52.5	453.
T 50.0	470.
I 47.5	487.
C 45.0	508.
A 42.5	530.
L 40.0	484.
37.5	462.
A 35.0	467.
N 32.5	519.
G 30.0	686.
L 27.5	738.
E 25.0	732.
22.5	715.
20.0	699.
17.5	694.
15.0	683.
12.5	677.
10.0	676.
7.5	675.
5.0	669.
2.5	665.
0.0	665.

CONE OF MAXIMUM CANDELA